









RECTANGULAR HANDRAIL WORKSHEET AND QUOTE FORM

Name: _____	Quote/PO: _____
E-mail: _____	Phone: _____
Company: _____	Date: _____
Address: _____	

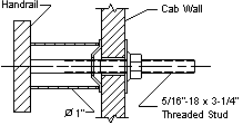
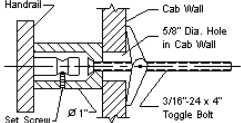
Info

							
Stainless steel		Bronze (brass)		Standard spacer	Removable spacer	Toggle bolt	SnapToggle bolt

Rectangular handrails are made of stainless steel or bronze solid bar stock, stainless steel tubing aluminum filled at the ends and available with #4 brushed or #8 polished finish. Standard handrails come with 5/16"-18 x 3-1/4"L studs, standard spacers, spacer washers, and required access to back side of cab wall for installation. Removable handrails are designed for installation from inside the cab, and use spacers with set screw. Toggle bolts recommended, can be purchased separately. All spacers, normally one spacer for every 2 feet of handrail, located per customer requirements. Please choose desired options and dimensions on drawing below or choose **different handrail worksheet**.

Note: Custom-made orders are non-returnable. Please recheck before submitting.

Data

Material / Finish	Spacers	Bolts quantity
1/4" x 1 1/2" S/steel <input type="checkbox"/> Brushed <input type="checkbox"/> Polished	<input type="checkbox"/> Standard, 1-1/2"L x 1"Dia.	___ Toggle, 3/16"-24 x 4"L
3/8" x 2" S/steel <input type="checkbox"/> Brushed <input type="checkbox"/> Polished	<input type="checkbox"/> Removable, 1-1/2"L x 1"Dia.	___ Toggle, 1/4"-20 x 4"L
3/8" x 2" Bronze <input type="checkbox"/> Brushed <input type="checkbox"/> Polished	<input type="checkbox"/> Removable, 2-1/2"L x 1"Dia.	___ SnapToggle, 1/4"-20 x 3-5/8"L
3/8" x 2" S/steel/aluminum <input type="checkbox"/> Brushed	Handrails quantity: ___	

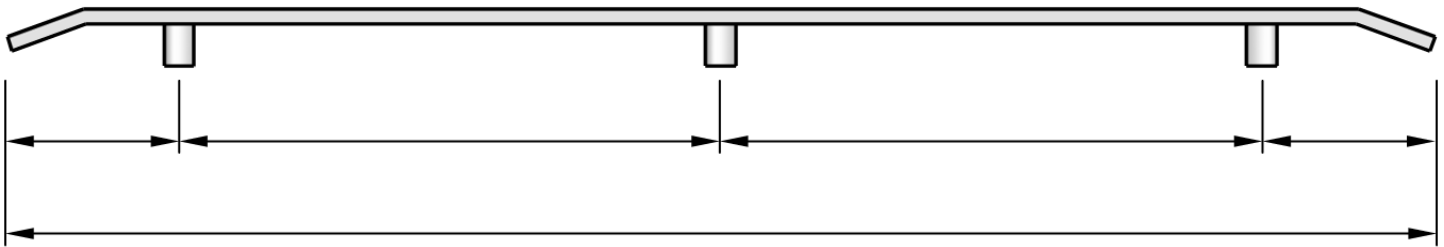

Notes

RRHRWS3B051315